

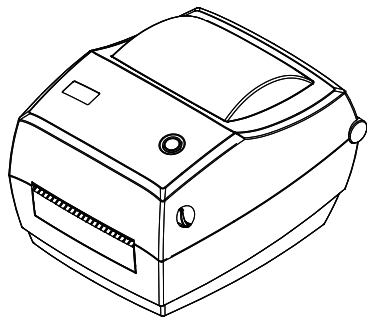

快速安装指南

电子面单打印机 ELP-168ES



广东天元印刷有限公司
Guangdong Tengen Printing Co., Ltd.

广东省东莞市清溪镇松岗
工业区上元路172号
电话：400 0836 800
传真：0769-89151002
主页：www.gdtengen.com



■ 标配件

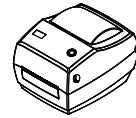

打印机

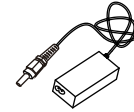

电源适配器



电源线



CD

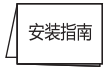

安装指南

安装指南

(含保修卡+合格证)

■ 选配件



USB数据线

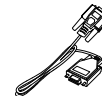

串口线

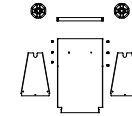

外置纸卷支架

外观及组件

■ 前视

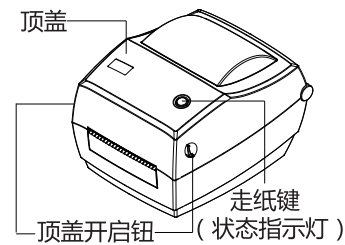

■ 后视

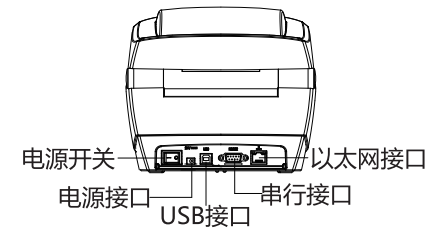

■ 开启顶盖

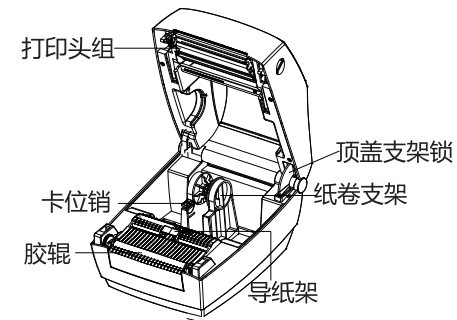

安装介质

1. 面对机器正面，双手同时按住顶盖开启钮，向上掀起顶盖。
2. 根据纸卷宽度适当拉开纸卷支架，插入纸卷。

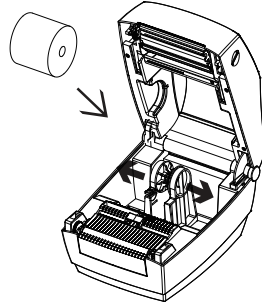
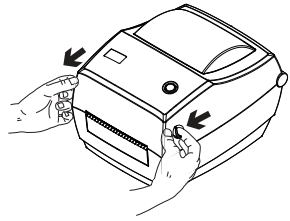

3. 确认纸卷紧紧贴着纸卷支架，按下卡位销。
4. 拉出部分纸卷穿过导纸架，依纸张宽度大小收合导纸架以固定纸张两侧。

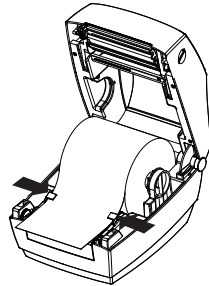
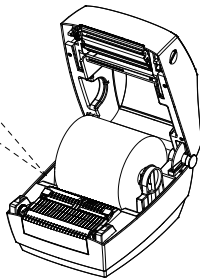
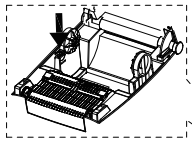

5. 抓住顶盖，并按顶盖支架锁将其松开，放下顶盖。
6. 向下按，直到顶盖咔一声锁闭，朝撕纸方向撕掉多余的纸张。

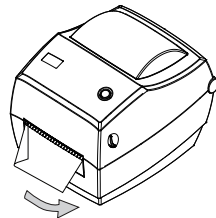
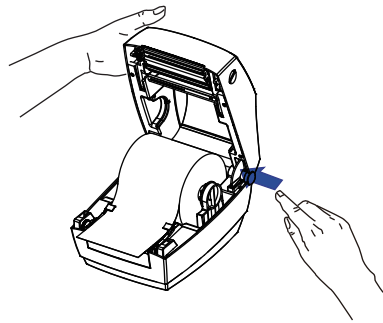

安装折叠纸

1. 将打印机适当垫高。
2. 将折叠式标签纸放在机器的后面。打印面朝上，从外置纸卷进口穿入打印机。

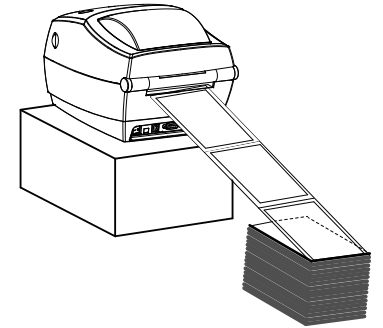
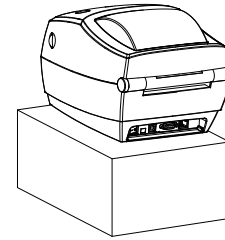

3. 将纸张由导纸架下方穿过，依纸张宽度大小收合导纸架杆以固定纸张两侧。
4. 向下按，直到顶盖咔一声锁闭。

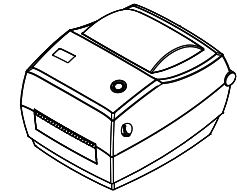
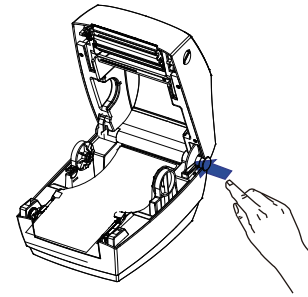

连接电源

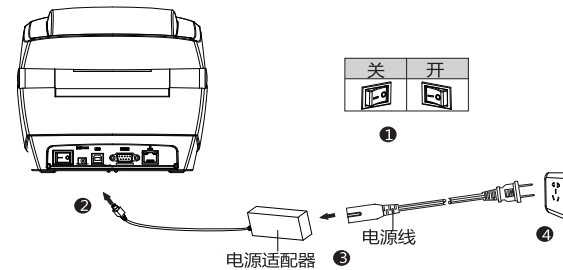

1. 确认打印机电源开关处于关闭(O)状态。
2. 将电源适配器连接到打印机。
3. 将电源线连接到电源适配器。
4. 将电源线另一端连接到附近的插座。